

Part number:

HYDROMA

HYDRAULICKÉ SYSTÉMY

**HIDROMA
SYSTEMS**

UKŁADY HYDRAULICZNE

HYDROMA

ГИДРАВЛИЧЕСКИЕ СИСТЕМЫ

FRB-RFA

RETURN FILTERS

MATERIALS

Head : Aluminium alloy
Cover and Bowl : Polyamide
Bypass valve: Polyamide
Seals: NBR Nitrile
Indicator housing: Brass

PRESSURE

Max. working: 700 kPa (7 bar)
Collapse, differential for the filter element (ISO 2941):
300 kPa (3 bar)

BYPASS VALVE

Setting: 170 kPa (1,7 bar) \pm 10%

WORKING TEMPERATURE

From -25° to +110° C

COMPATIBILITY (ISO 2943)

Full with fluids: HH-HL-HM-HV-HTG
(according to ISO 6743/4)
For fluids different than the above mentioned,
please contact our Customer Service.

HYDRAULIC DIAGRAM

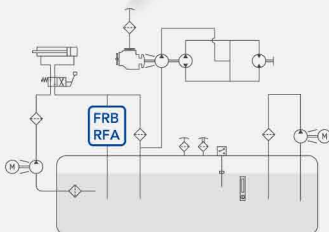

Is this datasheet the latest release? Please check on our website.



FRB

RETURN FILTERS

ORDERING AND OPTION CHART

F	R	B	COMPLETE FILTER FAMILY					FILTER ELEMENT FAMILY	E	R	B
			SIZE & LENGTH	11	21	22	23	SIZE & LENGTH			
			PORT TYPE								
			B = BSP thread	B	B	B	B				
			N = NPT thread	N	N	N	N				
			S = SAE thread	S	S	S	S				
			PORT SIZE								
			04 = 1/2"	04	-	-	-				
			06 = 3/4"	06	06	06	06				
			08 = 1"	-	08	08	08				
		B	BYPASS VALVE								
			B = 170 kPa (1,7 bar)- 250 kPa (2,5 bar) for media F+	B	B	B	B				
		N	SEALS					SEALS		N	
			N = NBR Nitrile	N	N	N	N				
			FILTER MEDIA					FILTER MEDIA			
			FA = fibreglass 5 µm(c) β>1.000	FA	FA	FA	FA				
			FB = fibreglass 7 µm(c) β>1.000	FB	FB	FB	FB				
			FC = fibreglass 12 µm(c) β>1.000	FC	FC	FC	FC				
			FD = fibreglass 21 µm(c) β>1.000	FD	FD	FD	FD				
			CC = impregnated cellulose 10 µm β>2	CC	CC	CC	CC				
			CD = impregnated cellulose 25 µm β>2	CD	CD	CD	CD				
			CLOGGING INDICATOR								
			05 = nr. 2 x 1/8" ports, plugged	05	05	05	05				
			30 = pressure gauge, rear connection	30	30	30	30				
			P4 = SPDT pressure switch	P4	P4	P4	P4				
			P6 = SPDT pressure switch	P6	P6	P6	P6				
			ACCESSORIES								
			W = without	W	W	W	W				
			C = with polyester air breather	C	C	C	C				
			D = with metal air breather	D	D	D	D				
			ACCESSORIES								
			W = without	W	W	W	W				
			H = with dipstick	H	H	H	H				

SPARE PARTS ELEMENTS

FILTER HOUSING				FILTER ELEMENT				CLOGGING INDICATOR				ACCESSORIES							
																			
B	R	B		B	N														

RFA

RETURN FILTERS

ORDERING AND OPTION CHART

R	F	A	COMPLETE FILTER FAMILY					FILTER ELEMENT FAMILY	C	R	A
			SIZE & LENGTH	110	210	220	230	SIZE & LENGTH			
			FILTER MEDIA					FILTER MEDIA			
			FT = fibreglass 5 µm(c) β>1.000	FT	FT	FT	FT				
			FC = fibreglass 7 µm(c) β>1.000	FC	FC	FC	FC				
			FD = fibreglass 12 µm(c) β>1.000	FD	FD	FD	FD				
			FV = fibreglass 21 µm(c) β>1.000	FV	FV	FV	FV				
			CD = impregnated cellulose 10 µm β>2	CD	CD	CD	CD				
			CV = impregnated cellulose 25 µm β>2	CV	CV	CV	CV				
		1	SEALS					SEALS		1	
			1 = NBR Nitrile	1	1	1	1				
		B	BYPASS VALVE								
			B = 170 kPa (1,7 bar)- 250 kPa (2,5 bar) for media F+	B	B	B	B				
			PORT TYPE								
			B = BSP thread	B	B	B	B				
			N = NPT thread	N	N	N	N				
			S = SAE thread	S	S	S	S				
			PORT SIZE								
			3 = 1/2"	3	-	-	-				
			4 = 3/4"	4	4	4	4				
			5 = 1"	-	5	5	5				
			CLOGGING INDICATOR								
			05 = nr. 2 x 1/8" ports, plugged	05	05	05	05				
			30 = pressure gauge, rear connection	30	30	30	30				
			P4 = SPDT pressure switch	P4	P4	P4	P4				
			P6 = SPDT pressure switch	P6	P6	P6	P6				
			ACCESSORIES								
			S = without	S	S	S	S				
			C = with polyester air breather	C	C	C	C				
			D = with metal air breather	D	D	D	D				
			ACCESSORIES								
			S = without	S	S	S	S				
			H = with dipstick	H	H	H	H				

SPARE SEAL KIT

NRB

FRB11 RFA110	521.0016.2
FRB21 RFA210	521.0017.2
FRB22 RFA220	521.0017.2
RB23 RFA230	521.0017.2

SPARE SPRING

FRA11 RFM004	008.0208.1
FRA21 RFM008	008.3014.1
FRA31 RFM012-015	008.3014.1
FRA32 RFM020-025	008.3014.1

FRB-RFA

RETURN FILTERS

INSTALLATION DRAWING

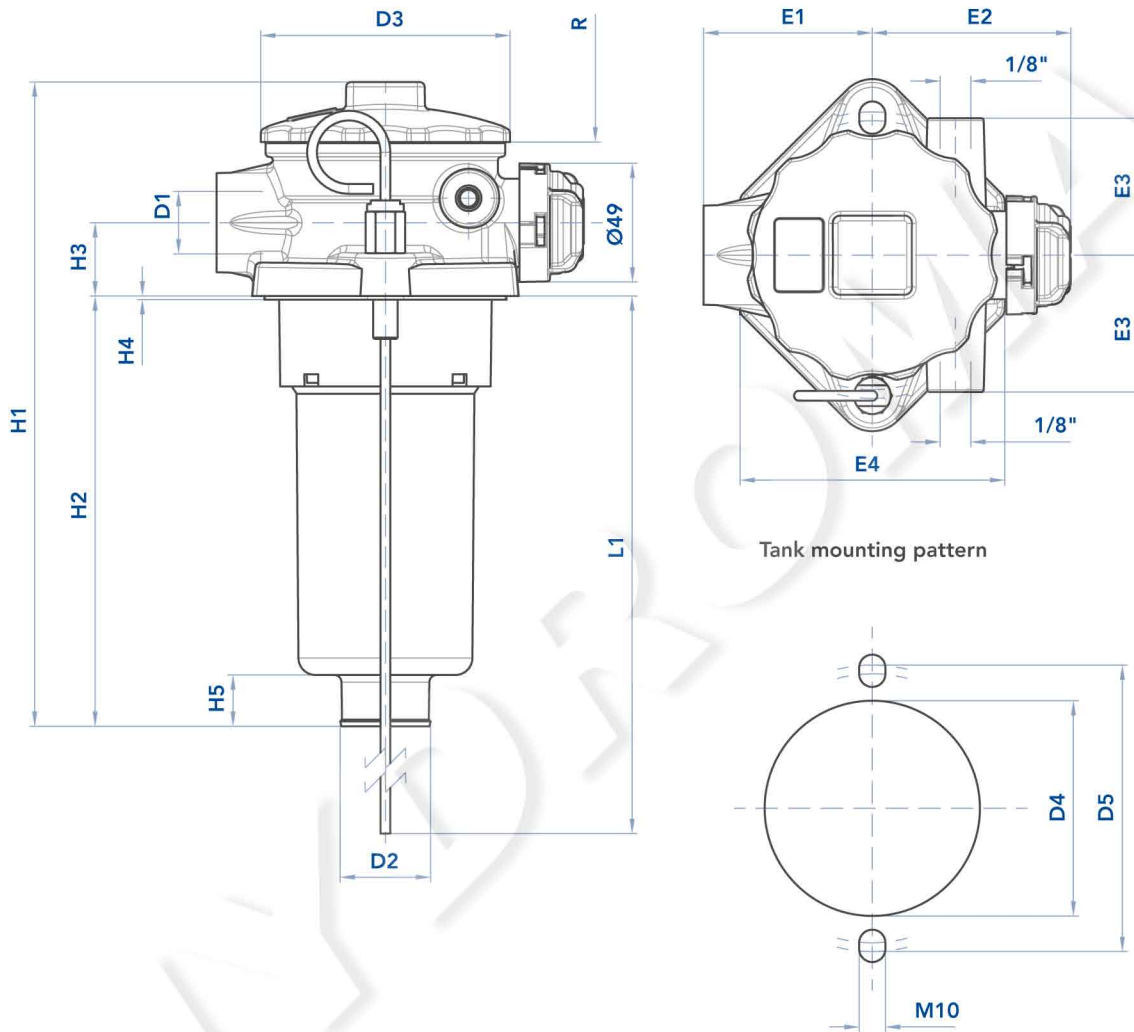

FILTER HOUSING

	D1	D2	D3	D4	D5	E1	E2	E3	E4	H1	H2	H3	H4	H5	L1	R	Kg
FRB11 RFA110	1/2" - 3/4"	28	75	60÷63	82÷88	50	70	28	77	243	178	24	2	16	380	220	0,40
FRB21 RFA210	3/4" - 1"	36	104	87÷91	110÷115	70	83	37	108	200	110	30	1,5	22	370	190	0,84
FRB22 RFA220	3/4" - 1"	36	104	87÷91	110÷115	70	83	37	108	265	175	30	1,5	22	370	240	0,87
FRB23 RFA230	3/4" - 1"	36	104	87÷91	110÷115	70	83	37	108	365	275	30	1,5	22	370	350	0,92



MAINTENANCE

The best time to change your filter element is just before it reaches its maximum dirt-holding capacity. For this reason, we recommend to monitor the pressure of the hydraulic oil flowing through the filter with a clogging indicator. When it is time to change the filter element, switch off the system before opening the filter housing. Unscrew the cover of the filter head and remove the spring (to be hold) and the dirty filter element. Replace it with an original UFI element, verifying the

part number on the filter label or on the catalogue. Clean the bowl; check the gaskets conditions and replace if necessary. Insert the clean element and the spring into his seat, handling with care and cleanliness. Replace the cover on the filter head with the screw.

We recommend the stocking of a spare UFI filter element for timely replacement when required.

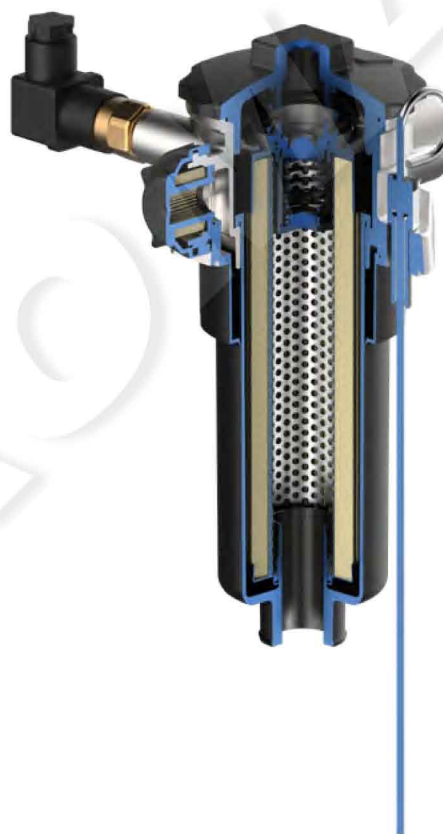
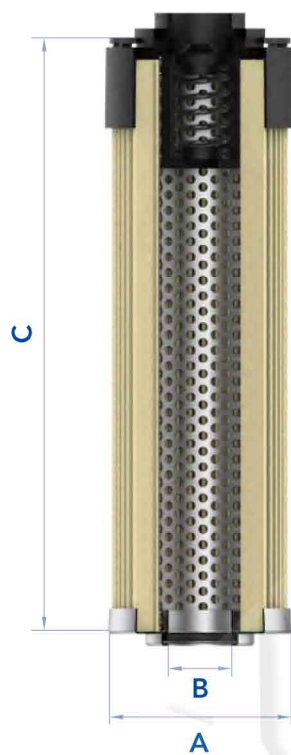

FILTER ELEMENT

	A	B	C	Kg	AREA (cm ²)	
					Media F+	MediaC+
ERB11 CRA110	43	20	200	0,20	1.225	1.225
ERB21 CRA210	59	28	134	0,30	1.500	1.500
ERB22 CRA220	59	28	200	0,40	2.295	2.295
ERB23 CRA230	59	28	300	0,50	3.495	3.495

The used filter elements cannot be cleaned and are classified as "Dangerous waste material". They must be disposed according to local laws by authorized Companies.

Verify that the Company you choose has the expertise and authorization to dispose this type of waste material.

FRB-RFA

RETURN FILTERS

PRESSURE DROP CURVES (Δp)

The "Assembly Pressure Drop (Δp)" is obtained by adding the pressure drop values of the Filter Housing and of the Clean Filter Element corresponding to the considered Flow Rate and it must

be lower than 50 kPa (0,5 bar) and should never exceed 1/3 of the bypass valve setting.

FILTER HOUSING PRESSURE DROP
(mainly depending on the port size)

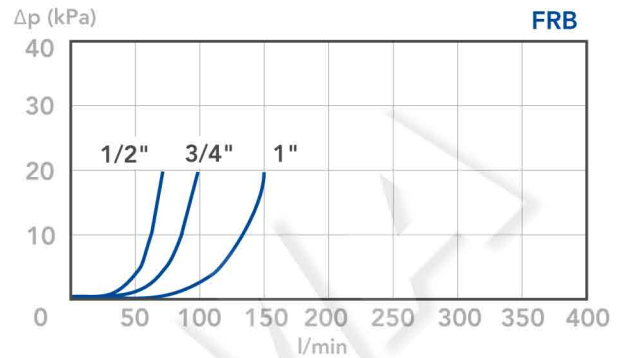

CLEAN FILTER ELEMENT PRESSURE DROP WITH F+ AND C+ MEDIA
(depending both on the internal diameter of the element and on the filter media)

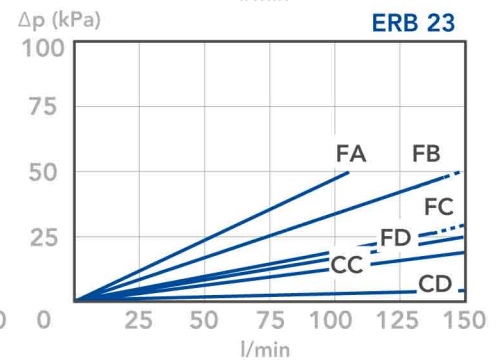
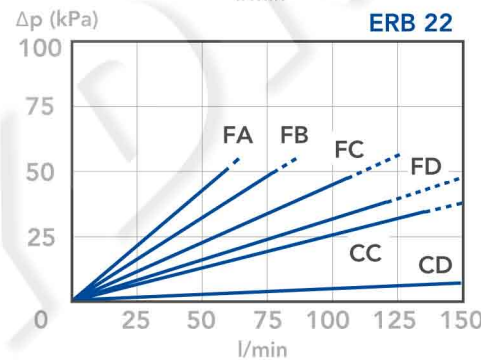
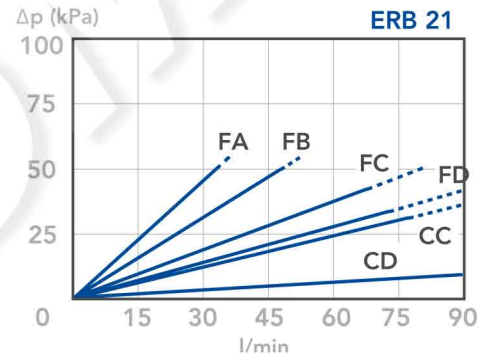
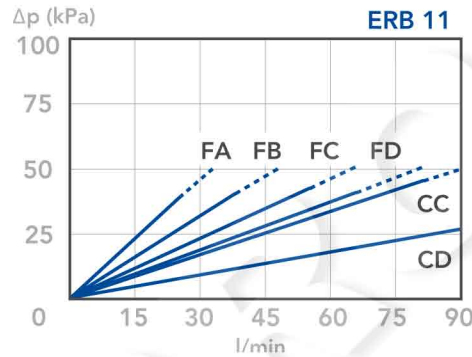

BYPASS VALVE PRESSURE DROP

When selecting the filter size, these curves must be taken into account if it is foreseen that any flow peak is to be absorbed by the bypass valve, it also must be of proper configuration to avoid pressure peaks. The valve pressure drop is directly proportional to fluid specific gravity.

N.B.

All the curves have been obtained with mineral oil having a kinematic viscosity 30 cSt and specific gravity 0,86 Kg/dm³; for fluids with different features, please consider the factors described in the first part of this catalogue. All the curves are obtained from test done at the UFI HYDRAULIC DIVISION Laboratory, according to the specification ISO 3968. In case of discrepancy, please check the contamination level, viscosity and features of the fluid in use.

