

Part number:



HYDROMA

HYDRAULICKÉ SYSTÉMY

**HIDROMA
SYSTEMS**

UKŁADY HYDRAULICZNE

HYDROMA

ГИДРАВЛИЧЕСКИЕ СИСТЕМЫ

Solenoid operated valves pilot operated poppet type
2-way normally closed
Special cavity, 017-E

VEI-16-NC

OD.15 - X - 17 - Y - Z

RE 18323-34

Edition: 04.2021

Replaces: 03.2020



PATENT PENDING

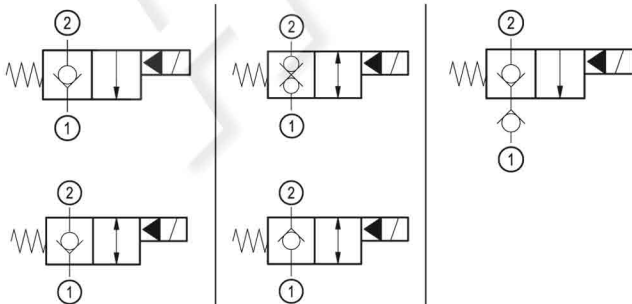
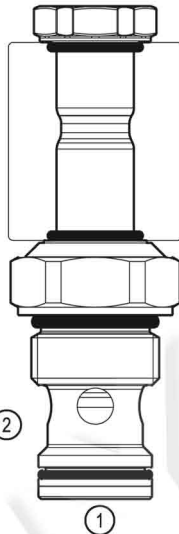

Technical data

New VEI-16 family incorporates a new solenoid concept providing excellent performance and enables cartridges to work in severe environment. Cartridges also incorporates advanced design of hydraulic parts providing excellent hydraulic performance.

Technical data

| General | |
|--|--|
| Weight | 0.25 kg (0.55 lbs) |
| Installation orientation | Unrestricted |
| Storage ambient temperature range | -40 to 100 °C (-40 to 212 °F) |
| Operating ambient temperature range | -30 to 90 °C (-22 to 194 °F) |
| Salt spray test to DIN EN ISO 9227:2017-07 | 500h |
| Hydraulic | |
| Max. operating pressure | 350 bar (5000 psi) |
| Flow range | 2 - 70 l/min (0.53 - 18 gpm) |
| Fatigue cycle life | 2 million cycles at 350 bar |
| Max. internal leakage | 5 drops/min. for X=01,05,11 20 drops/min. for X=03,31 |
| Installation torque | 54 - 66 Nm (40 - 49 ft-lbs) |
| Switching time | Opening ≤ 50 ms |
| | Closing ≤ 100 ms |
| Fluid temperature range | -20 to 80 °C (-4 to 176 °F) |
| Fluids: Mineral-based or synthetics with lubricating properties at viscosities of 20 to 380 mm ² /s (cSt) | |
| Recommended degree of fluid contamination | Nominal value max. 10 µm (NAS 8) ISO 4406 19/17/14 |
| MTTFD | 150 years see RE 18350-51 |
| Special cavity | 017-E see 18325-75 |
| Seal kit for X=01,05,11 | code RG17E201052010 |
| | material no. R934003562 |
| Seal kit for X=03,31 | code RG17E201053010 |
| | material no. R934003563 |
| Seal kit coil and standard cap | code RG02Z0010000100 |
| | material no. R930067869 |
| Seal kit coil and protective cap only for Y=D | code RG03Z0010000100 |
| | material no. R930067870 |
| Other technical data | See data sheet 18350-50 |
| Electrical | |
| Type of voltage | DC voltage |
| Coil type | D36 |
| Supply voltage | See data sheet 18325-90 |
| Voltage tolerance against ambient temperature | See characteristic curve |
| Power consumption | 20 W |
| Type of protection | See data sheet 18325-90 |
| Note: Coils must be ordered separately | |

Ordering code

| | | | | | | |
|--------------|----------|-----------|----------|----------|-------------|----------|
| OD.15 | X | 17 | Y | Z | 0000 | * |
|--------------|----------|-----------|----------|----------|-------------|----------|

Solenoid operated valves
pilot operated poppet type
2-way normally closed

Series O/A to L
unchanged performances and dimensions

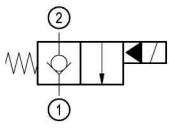
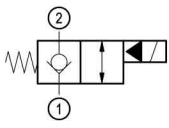
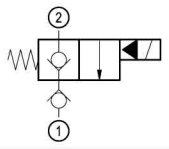
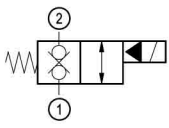
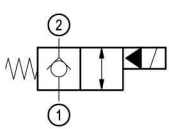
| | |
|--|---|
| <p>monodirectional type</p>  <p style="text-align: right;">01</p> | <p>0 = With buna seal 8 = With buna seal and extra spring only for 03, 05, 31 V = With Viton seal P = With buna seal and protective cap for override version D T = With Viton seal and protective cap for override version D</p> |
| <p>bidirectional type</p>  <p style="text-align: right;">05</p> | <p>A = Standard D = Knob style manual override E = Pull style manual override F = Hand operated pull style manual override</p> |
| <p>monodirectional type with check</p>  <p style="text-align: right;">11</p> | <p>Special cavity: 017-E</p> |
| <p>bidirectional type</p>  <p style="text-align: right;">31</p> | |
| <p>bidirectional type</p>  <p style="text-align: right;">03</p> | |

Preferred types

| Type | Material number |
|-----------------|-----------------|
| OD150117A000000 | R930062337 |
| OD150117D000000 | R930065472 |
| OD150517A000000 | R930062338 |
| OD150517D000000 | R930064099 |
| OD151117A000000 | R930064362 |
| OD150517DP00000 | R930066439 |
| OD153117A000000 | R930065028 |
| OD153117D000000 | R930067162 |

| Type | Material number |
|-----------------|-----------------|
| OD150317A000000 | R930066965 |
| OD150317D000000 | R930066967 |
| OD150517A800000 | R930065551 |
| OD150317A800000 | R930065610 |
| OD150517E000000 | R930070202 |
| OD153117A800000 | R930066700 |
| OD153117D800000 | R930067588 |

Dimensions

**Solenoid operated valves pilot operated poppet type
2-way normally closed**

Hand operated Pull style manual override

